

CM5004-FRONT

Product details are available at <https://www.fhgroupauto.com/product/chevy-equinox>



Warning

- Machine wash cold, delicate cycle. Air dry only.
- Avoid sharp objects to protect covers from being scratched/damaged.
- We suggest wearing protective eyewear and gloves during installation.

Included Hardware

- 8 Hooks

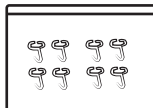

Package Includes

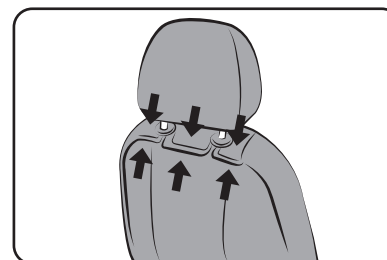
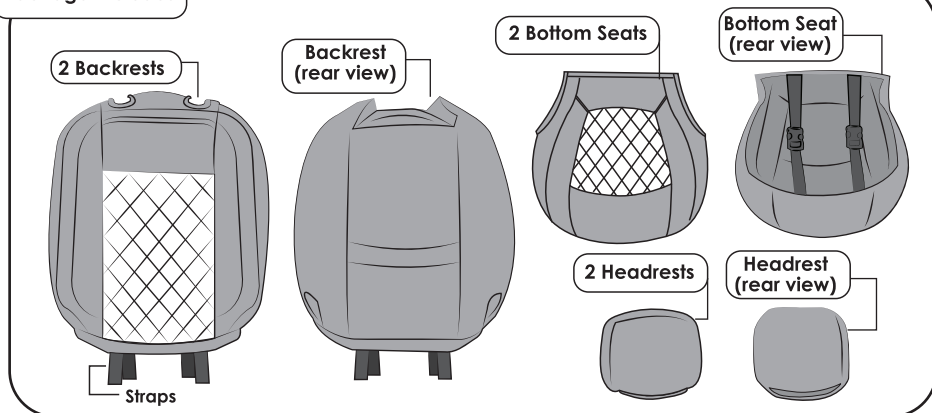

- ③ After the backrest is pulled down, close the top by securing the hook-and-loop pieces together around the base of the headrest.

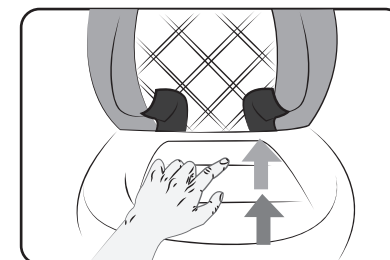

- ④ Push the straps through the seat crevice, and position the straps to the back of the seat.

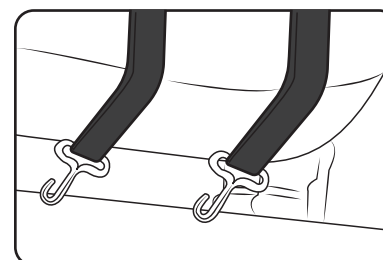

- ⑤ Locate the two hooks in the bag. Attach the hooks to the straps that were pushed through the crevice. Find a secure place to attach the hooks underneath your car seat.

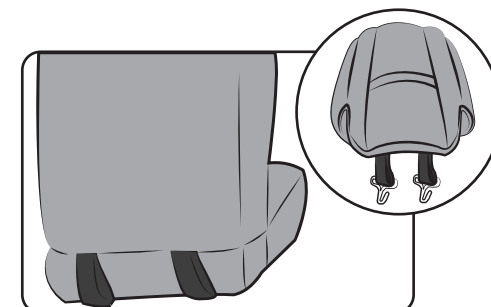

- ⑥ Remove the additional hooks from the bag and add them to the two remaining straps located on the back of the backrest cover. Attach the hooks to the bottom portion of the seat, as shown above.

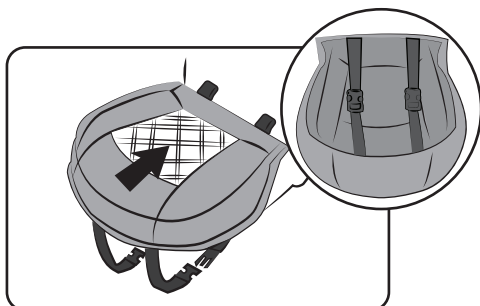

- ① Slide the bottom seat covers onto the seat. Push the rear straps through the seat crevice. Attach the rear and front straps underneath the seat using the buckles.

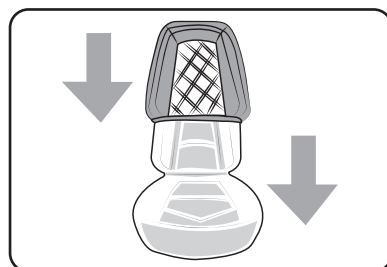

- ② Open the hook-and-loop closures at the top of the backrest. Slide the backrest cover down over the headrest.

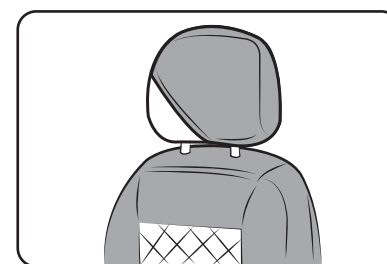

- ⑦ Slip on the headrest cover. TIP: Starting from either side of the headrest and sliding the cover sideways will help you achieve a secure fit.

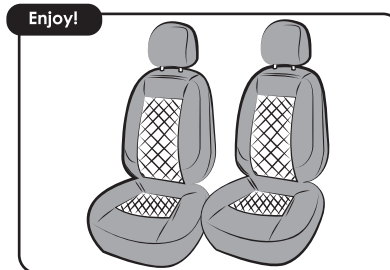

- ⑧ Adjust accordingly, smooth out your custom fit seat covers and enjoy!

CM5004-REAR



Video instructions are available at
<https://www.fhgroupauto.com/product/chevy-equinox>

Warning

- Machine wash cold, delicate cycle. Air dry only.
- Avoid sharp objects to protect covers from being scratched/damaged.
- We suggest wearing protective eyewear and gloves during installation.

PACKAGE INCLUDES

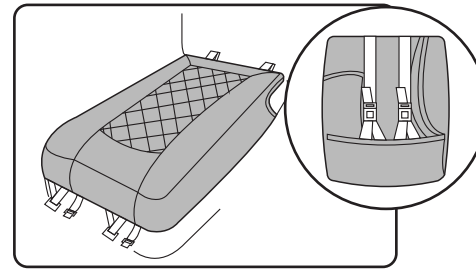
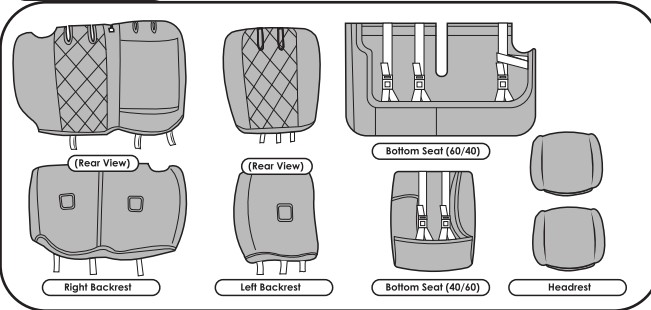

- 5 Attach the buckles for your bottom 40/60 split covers according to the image above.

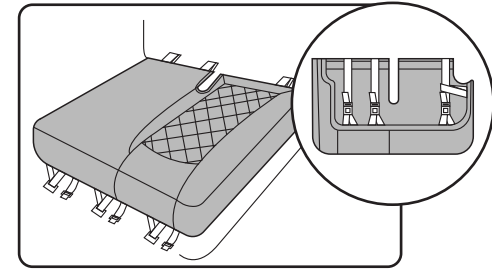

- 6 Place the bottom seat cover on the bench seat cushion and attach the buckles as shown above. Once complete, reattach the bottom bench seat cushion to the vehicle.

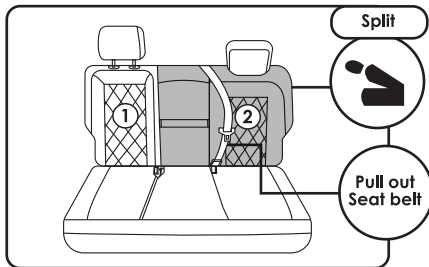

- 1 Unzip each backrest cover section and pull bench backrests forward individually to slide the cover down. Making sure to pull out your vehicle's seat belt before you zip up the cover.

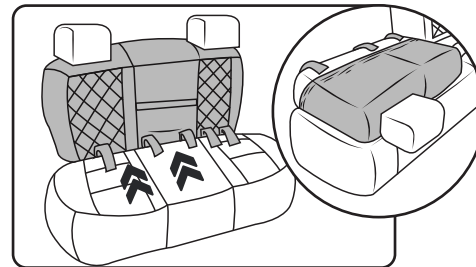

- 2 Push the rear hook-and-loop straps through the seat crevice. Attach the rear hook-and-loop straps directly to the upholstery of the backseats.

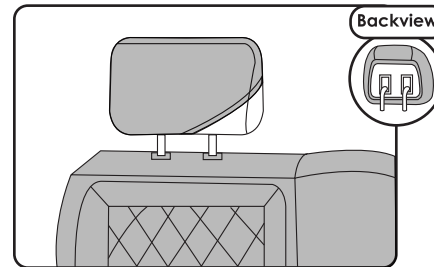

- 7 Slip on the headrest cover and reattach the headrests. TIP: Starting from either side of the headrest and sliding the cover sideways will help you achieve a secure fit.

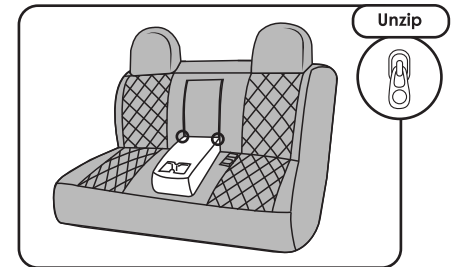

- 8 To gain access to the rear center console, please unzip the zipper provided.

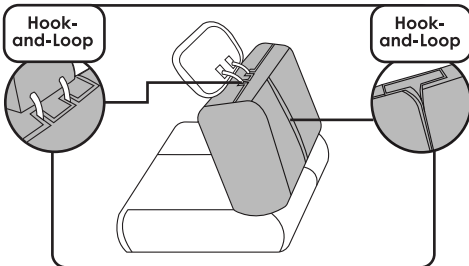

- 3 After the backrest is pulled down, close the top by securing the hook-and-loop pieces together around the base of the headrest

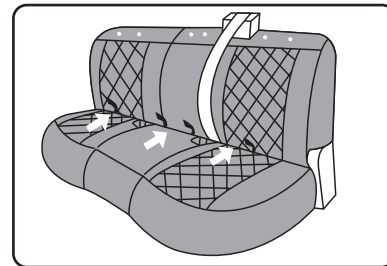

- 4 Place the bottom seat cover on the bench seat cushion and push the buckle straps to the center crevice of your car seat.

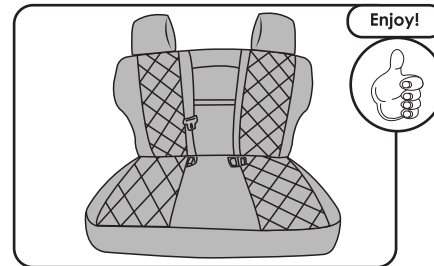

- 9 Adjust accordingly, smooth out your custom fit seat covers and enjoy!