

CM5007-REAR

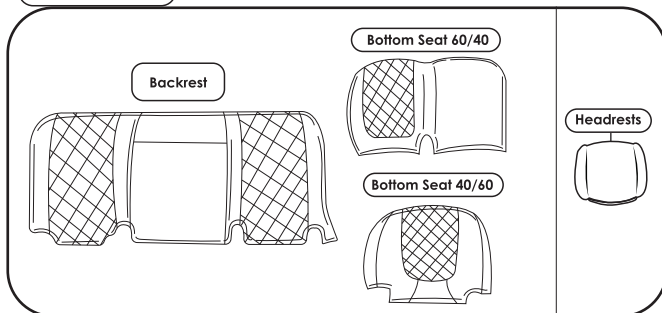

Product details are available at
<https://www.fhgroupauto.com/product/gmc-sierra/>

PACKAGE INCLUDES



Warning

- Machine wash cold, delicate cycle. Air dry only.
- Avoid sharp objects to protect covers from being scratched/damaged.
- We suggest wearing protective eyewear and gloves during installation.

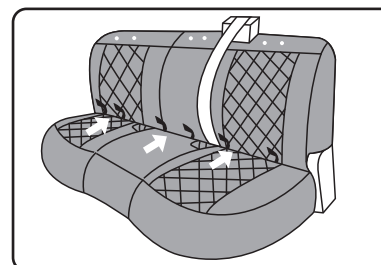

- 5 Place the bottom 60/40 and 40/60 seat covers on the bench seat cushion and push the buckle straps to the center crevice of your car seat.

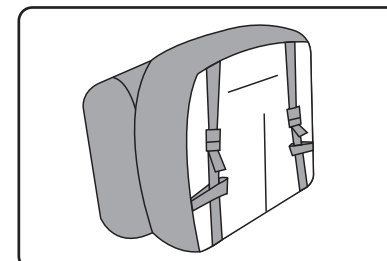

- 6 Attach the buckles for your bottom 40/60 split covers according to the image above.

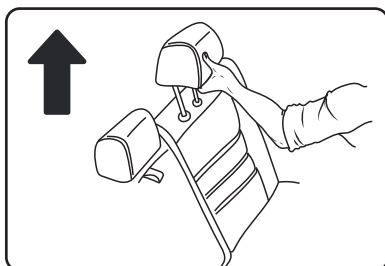

- 1 To start, remove the headrest by pushing the release button at the base of the headrest.

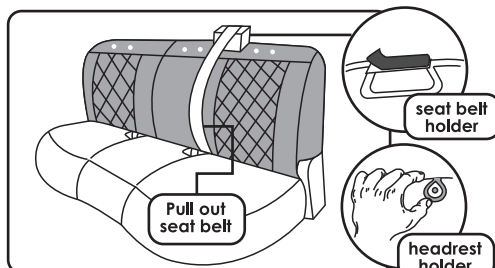

- 2 Pull out the seat belt and place the seat cover underneath it. Tuck in the sides of the seat cover into the crevices of the rear seat. Follow the contour of your car seat. Make sure you close the hook and loop strap near the seat belt holder.

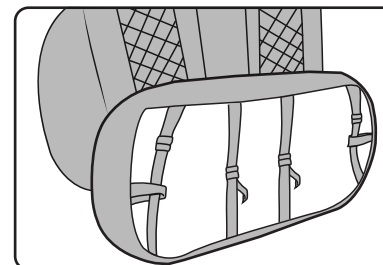

- 7 Attach the buckles for your bottom 60/40 split covers according to the image above.

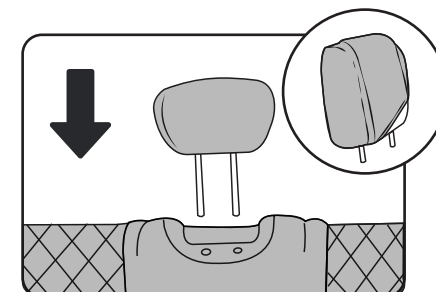

- 8 Slip on the headrest cover and reattach the headrests. TIP: Starting from either side of the headrest and sliding the cover sideways will help you achieve a secure fit.

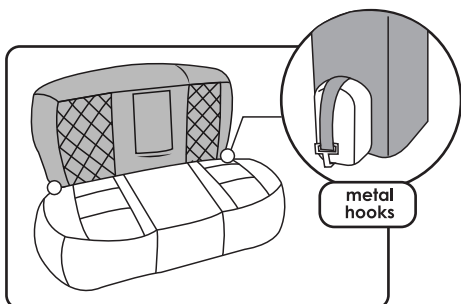

- 3 Attach the metal hooks provided to the corner straps of the seat covers. Hook the straps to the corners of your car seat. Refer to the example in the picture above.

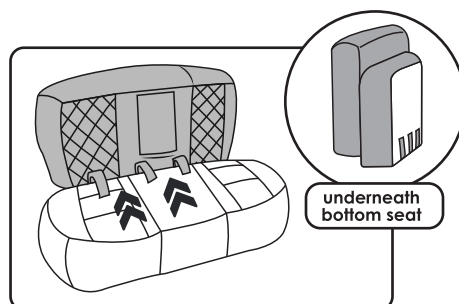

- 4 Push the rear hook-and-loop straps through the seat crevice. Lift up the bottom seat and attach the rear hook-and-loop straps underneath the bottom seat.

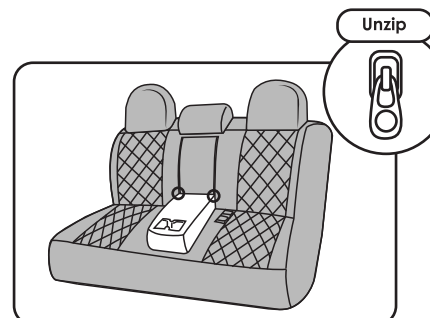

- 9 To gain access to the rear center console, please unzip the zipper provided.

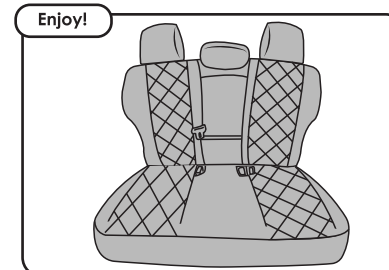

- 10 Adjust accordingly, smooth out your custom-fit seat covers, and enjoy!