

# CM5011-REAR

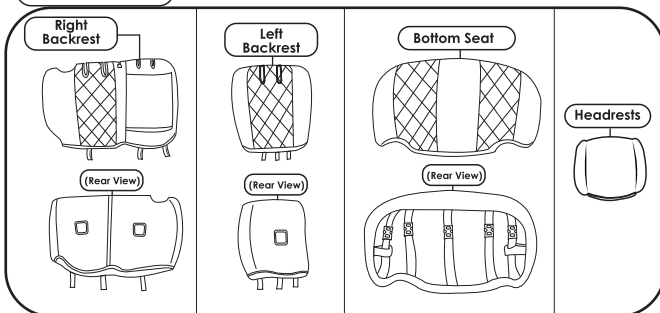

Video instructions are available at <https://www.fhgrouppauto.com/product/seat-covers-2019-2022-toyota-rav4-full-set/>

## PACKAGE INCLUDES



## Warning

- Machine wash cold, delicate cycle. Air dry only.
- Avoid sharp objects to protect covers from being scratched/damaged.
- We suggest wearing protective eyewear and gloves during installation.

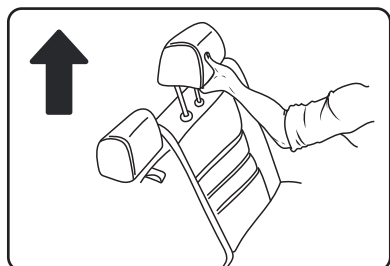

- 1 To start, remove the headrest by pushing the release button at the base of the headrest.

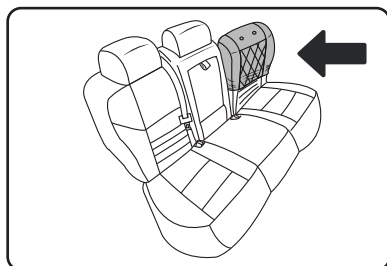

- 2 Pull the left split bench seat forward and slide the left backrest cover down.

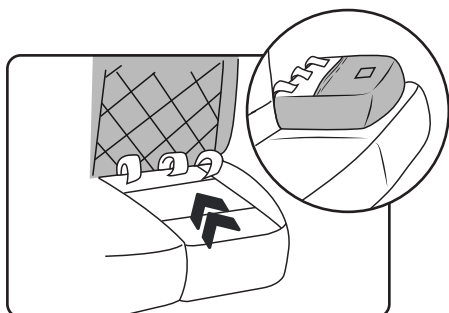

- 3 Push the hook-and-loop straps located on the bottom of the left backrest through the seat crevice. Attach the rear hook-and-loop straps directly to the upholstery of the backseats.

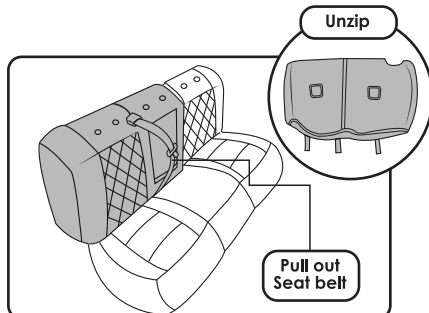

- 4 Unzip your right backrest cover and pull the right bench backrest forward and slide the cover down. Make sure you pull out your vehicles seat belt before you zip up the backrest cover.

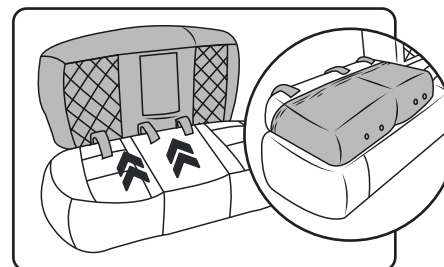

- 5 Push the rear hook-and-loop straps through the seat crevice. Attach the rear hook-and-loop straps directly to the upholstery of the backseats.

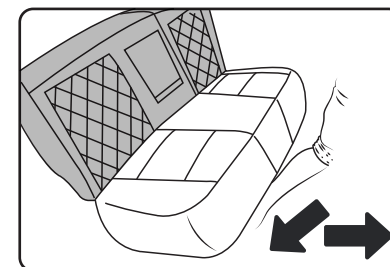

- 6 Remove the bottom seats by pushing diagonally inward then pulling the bottom bench seat cushion up and out.

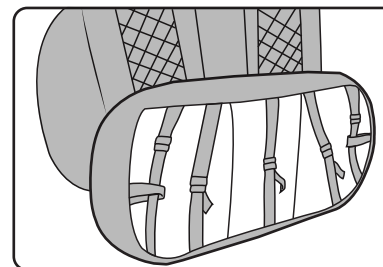

- 7 Place the bottom seat cover on the bench seat cushion and attach the buckles as shown above. Once complete, reattach the bottom bench seat cushion to the vehicle.

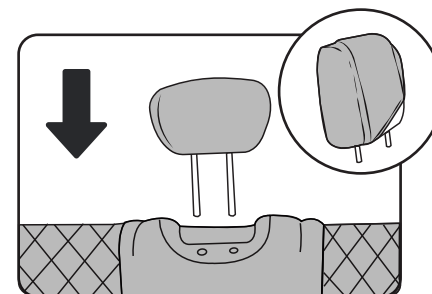

- 8 Slip on the headrest cover and reattach the headrests. TIP: Starting from either side of the headrest and sliding the cover sideways will help you achieve a secure fit.

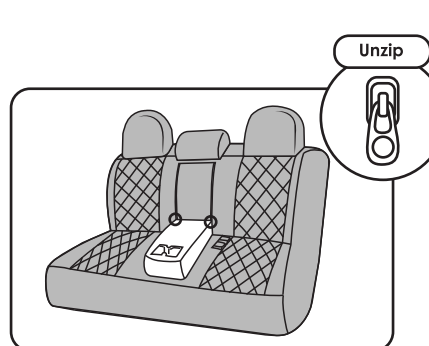

- 10 To gain access to the rear center console, please unzip the zipper provided.

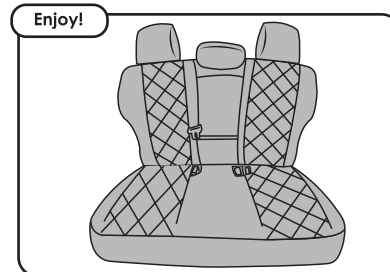

- 10 Adjust accordingly, smooth out your custom fit seat covers and enjoy!