

CM5014-REAR

Video instructions are available at
<https://www.fhgroupauto.com/product/honda-crv>



PACKAGE INCLUDES

Warning

- Machine wash cold, delicate cycle. Air dry only.
- Avoid sharp objects to protect covers from being scratched/damaged.
- We suggest wearing protective eyewear and gloves during installation.

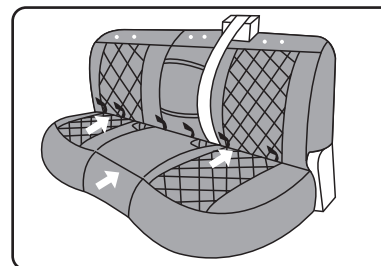
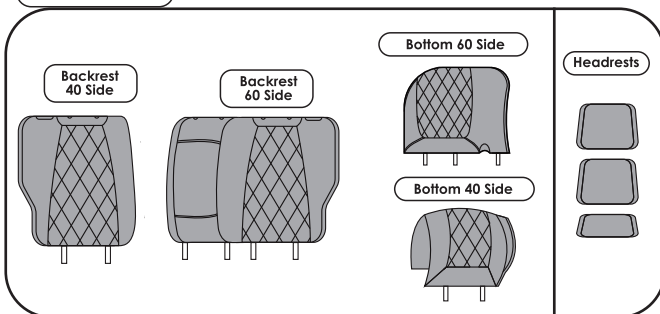

- 5 Place the Bottom 60 and 40 Side covers on the bench seat cushion and push the buckle straps to the center crevice of your car seat.

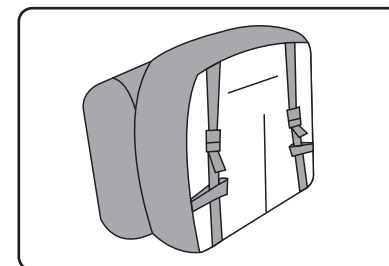

- 6 Attach the buckles of your Bottom 40 Side covers, according to the image above.

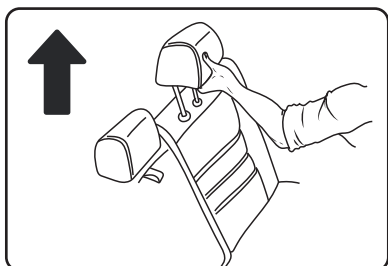

- 1 To start, remove the headrest by pushing the release button at the base of the headrest.

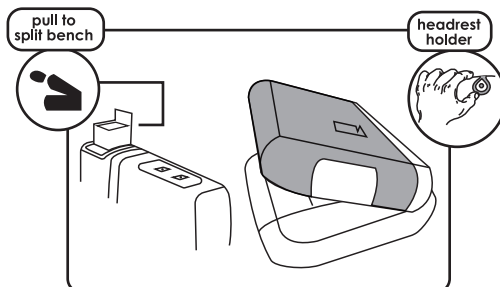

- 2 Slide the backrest 60 side cover onto backrest following the contour of the seat, until it's fully on the backrest. Then, close the hook-and-loop straps near the seatbelt holder and tuck in the reminder fabric in the seat crevice

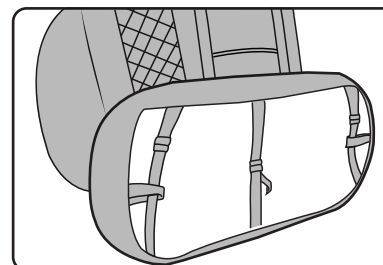

- 7 Attach the buckles of your Bottom 60 Side covers, according to the image above.

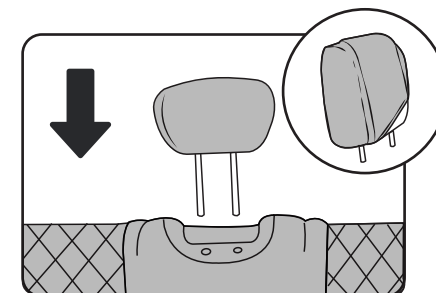

- 8 Slip on the headrest cover and reattach the headrests. TIP: Starting from either side of the headrest and sliding the cover sideways will help you achieve a secure fit. Repeat same process for all headrests.

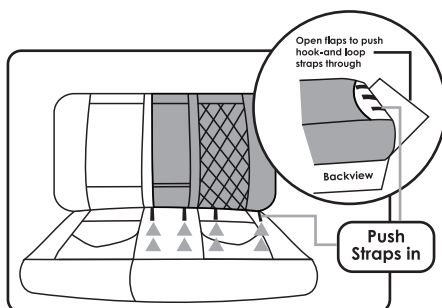

- 3 Push the rear hook-and-loop straps through the seat crevice. Attach the straps directly to the upholstery of the backseats.

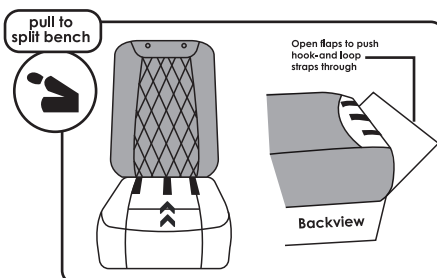

- 4 For the Backrest 40 Side, push the rear hook-and-loop straps through the seat crevice. Attach the straps directly to the upholstery of the backseats.

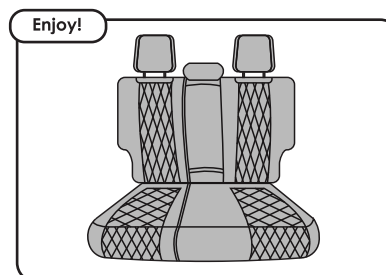

Enjoy!

- 9 Adjust accordingly, smooth out your custom-fit seat covers, and enjoy!