

CM5022-FRONT SEAT COVERS

Video instructions are available at

<https://www.fhgroupauto.com/product/custom-fit-seat-covers-2020-2022-jeep-gladiator-full-set/>

SCAN ME



WARNING

- Machine wash cold, delicate cycle. Air dry only.
- Avoid sharp objects to protect covers from being scratched/damaged.
- We suggest wearing protective eyewear and gloves during installation.

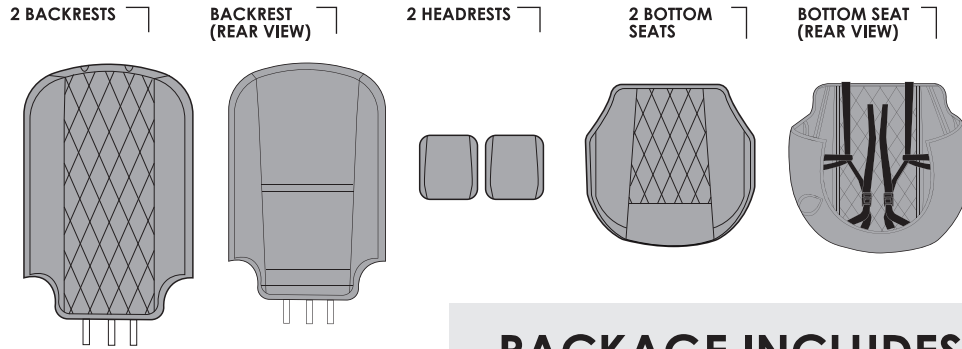

PACKAGE INCLUDES

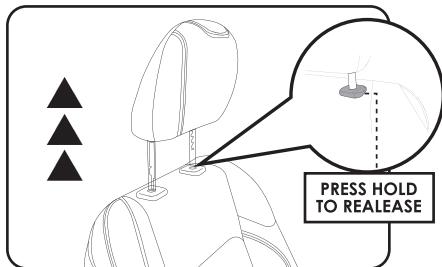

- 1 Detach the headrest by pressing the button located at the base of the headrest. Then simply lift the headrest to separate it from the backrest.

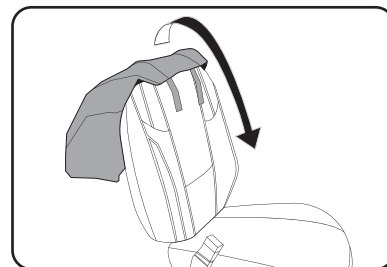

- 2 Place the backrest cover over the seat making sure the headrest openings are aligned accordingly.

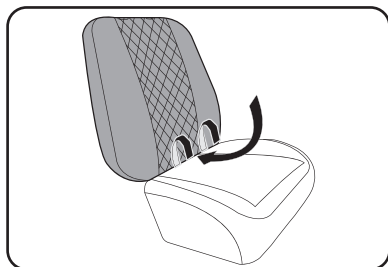

- 3 Insert the front straps through the crevice of the seat and push them until they come out at the back of the seat.

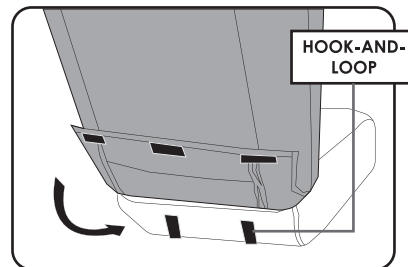

- 4 Locate the hook-and-loop attachments at the back of the backrest cover and attach them directly to the seat's upholstery. Please repeat the previous steps to install the other backrest cover.

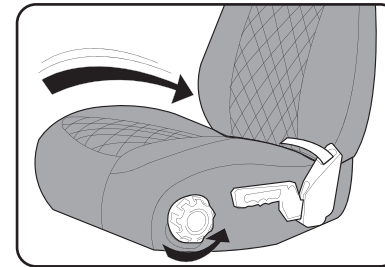

- 5 To install the bottom cover, place it on your car seat making sure it follows the contour of your seat. Then, tuck in the corners of the cover and ensure the cover aligns and accommodates the seat's controls.

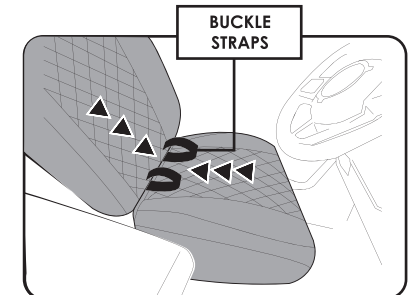

- 6 Push the buckle straps through the seat crevice.

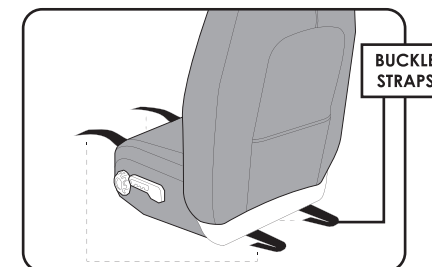

- 7 Connect together the front and rear buckle straps under the seat as shown in the following step.

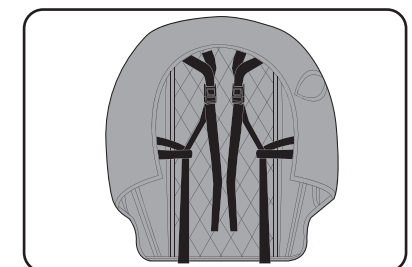

- 8 Your buckle straps should be connected together as shown in the image above.

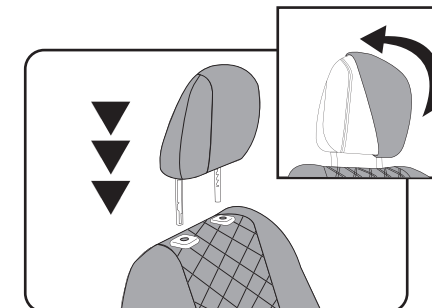

- 9 Reattach the headrests to the seats and slip on the headrest covers. TIP: Starting from either side of the headrest and sliding the cover sideways will help you achieve a secure fit.

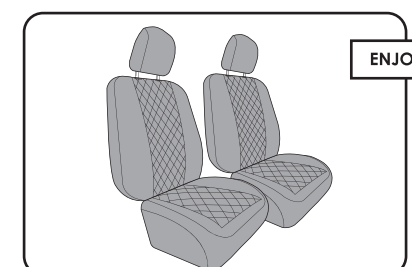

- 10 Adjust accordingly and smooth out your custom-fit seat cover.

ENJOY